



光学元器件

# 激光二极管

## CONTENTS

■ 红光/红外双波长激光二极管 .....	P. E22
■ 红光激光二极管 .....	P. E22
■ 红外激光二极管 .....	P. E23
■ 品名构成说明，记号和定义 .....	P. E24
■ 封装规格 .....	P. E26

**激光二极管**

红光/红外双波长激光二极管															
Part No.	Pitch (μm)	Wavelength λ <sub>P</sub> (nm)	Absolute Maximum Ratings (T <sub>C</sub> =25°C)			Electrical and Optical Characteristics (T <sub>C</sub> =25°C)							P <sub>O</sub> (mW)	Package	Equivalent Circuit
			P <sub>O</sub> (mW)	V <sub>R</sub> (V)	T <sub>opr</sub> Max. (°C)	I <sub>TH</sub> (mA)	I <sub>op</sub> (mA)	η (W/A)	V <sub>op</sub> (V)	I <sub>m</sub> (mA)	θ <sub>⊥</sub> (deg.)	θ// (deg.)			
RLD2WMNL2-00x (For Automotive)	110	663	7	2	85	18	24	0.70	2.3	0.25	28.0	10.0	5		
		785	7	2	85	15	20	0.70	1.8	0.25	32.0	10.0	5		
RLD2WMNL2-01x (Standard)	110	663	7	2	80	18	24	0.70	2.3	0.25	28.0	10.0	5		
		785	7	2	80	15	20	0.70	1.8	0.25	32.0	10.0	5		

 注: 1.除另行标注外, 所有电气及光学特性皆为标准值。  
 2.品名中的x为管理编号。

红光激光二极管														
Part No.	Wavelength λ <sub>P</sub> (nm)	Absolute Maximum Ratings (T <sub>C</sub> =25°C)			Electrical and Optical Characteristics (T <sub>C</sub> =25°C)							P <sub>O</sub> (mW)	Package	Equivalent Circuit
		P <sub>O</sub> (mW)	V <sub>R</sub> (V)	T <sub>opr</sub> Max. (°C)	I <sub>TH</sub> (mA)	I <sub>op</sub> (mA)	η (W/A)	V <sub>op</sub> (V)	I <sub>m</sub> (mA)	θ <sub>⊥</sub> (deg.)	θ// (deg.)			
RLD65MZT7	655	7	2	70	20	30	0.70	2.3	0.24	27.0	8.0	5		
RLD65MQX1 (Higher ESD)	660	10	2	70	15	21	0.85	2.3	0.15	27.0	9.0	5		
RLD63NZC5 (Pure red)	635	6	2	40	24	33	0.55	2.2	0.18	32.0	8.0	5		
RLD63NPC5 (Pure red)	635	6	2	40	24	33	0.55	2.2	0.18	32.0	8.0	5		
RLD63NPC6 (Pure red)	635	12	2	50	25	40	0.65	2.3	0.13	31.0	8.0	10		
RLD63NPC7 (Pure red)	638	17	2	50	35	57	0.60	2.3	0.20	30.0	8.0	15		
RLD63NPC8 (Pure red)	638	24	2	50	35	67	0.60	2.3	0.25	29.0	8.0	20		
<b>New</b> RLD65NZX1 (Higher temp.)	660	10	2	85	15	24	0.85	2.3	0.30	27.0	9.0	7		
RLD65NZX2 (Higher ESD)	655	7	2	70	25	33	0.60	2.3	0.20	28.0	8.5	5		
<b>New</b> RLD65NZX3 (Higher ESD)	655	12	2	70	25	42	0.60	2.3	0.20	28.0	8.5	10		
RLD65PZX2 (Higher ESD)	655	7	2	70	25	33	0.60	2.3	0.20	28.0	8.5	5		
RLD65PZX3 (Higher ESD)	655	12	2	70	25	42	0.60	2.3	0.20	28.0	8.5	10		

注: 除另行标注外, 所有电气及光学特性皆为标准值。



红外激光二极管															
Part No.	Wavelength $\lambda_p$ (nm)	Absolute Maximum Ratings (Tc=25°C)			Electrical and Optical Characteristics (Tc=25°C)								Po (mW)	Package	Equivalent Circuit
		PO (mW)	VR (V)	Topr Max. (°C)	ITR (mA)	Iop (mA)	$\eta$ (W/A)	Vop (V)	Im (mA)	$\theta_{\perp}$ (deg.)	$\theta_{//}$ (deg.)				
RLD78MZA6	790	4.5	2	70	25	35	0.35	1.9	0.15	37.0	11.0	3			
RLD78MZM7	792	20	2	60	11	33	0.65	1.8	0.50	24.0	8.5	15			
RLD78NZM5	793	10	2	60	11	20	0.55	1.8	1.15	28.0	9.0	6			
RLD78NZM7	792	20	2	60	11	33	0.65	1.8	0.90	24.0	8.5	15			
RLD82NZJ1	822	220	2	60	50	255	0.95	2.4	0.30	17.0	9.5	200			
RLD84NZJ2	842	220	2	60	50	255	0.95	2.4	0.30	17.0	9.5	200			
RLD85NZJ4	852	220	2	60	50	255	0.95	2.4	0.30	17.0	9.5	200			
☆RLD94NZJ5	942	285	2	65	55	325	0.75	2.2	0.90	30.0	35.0	200			
New RLD94NZJ7	942	220	2	60	50	255	0.95	2.4	0.30	17.0	9.5	200			
RLD78PZM7	792	20	2	60	11	33	0.65	1.8	0.65	24.0	8.5	15			
RLD82PZJ1	822	220	2	60	50	255	0.95	2.4	0.30	17.0	9.5	200			
RLD84PZJ2	842	220	2	60	50	255	0.95	2.4	0.30	17.0	9.5	200			
RLD85PZJ4	852	220	2	60	50	255	0.95	2.4	0.30	17.0	9.5	200			
☆RLD94PZJ5	942	285	2	65	55	325	0.75	2.2	0.90	30.0	35.0	200			
New RLD94PZJ7	942	220	2	60	50	255	0.95	2.4	0.30	17.0	9.5	200			

注: 除另行标注外, 所有电气及光学特性皆为标准值。

☆: 开发中

● 关于安全性

本目录所述产品旨在用于普通的电子设备或装置。激光二极管发出的光虽然肉眼几乎看不见, 但直视会引起视网膜损伤。

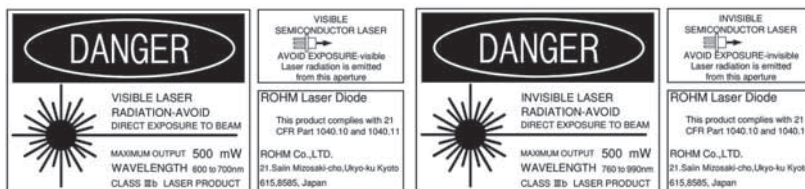

如果您需要在要求极高可靠性的、因产品故障或误操作会直接影响人身安全的机器或装置中使用我公司产品, 请事先向我们的销售代表咨询。

● 关于开封品

开封产品(包装MARK为P的产品), 由于外部环境的影响, 特性和可靠性有可能会降低。对于包含碳粉、人为异物、香烟烟雾在内的异物、离子导致的腐蚀、粘接剂及助焊剂的挥发性成分带来的影响、结露、光镊子效果等, 请采取足够完善的解决措施。此外, 请注意不得触碰包含激光芯片发光部的构成部件。

## ● 品名构成说明

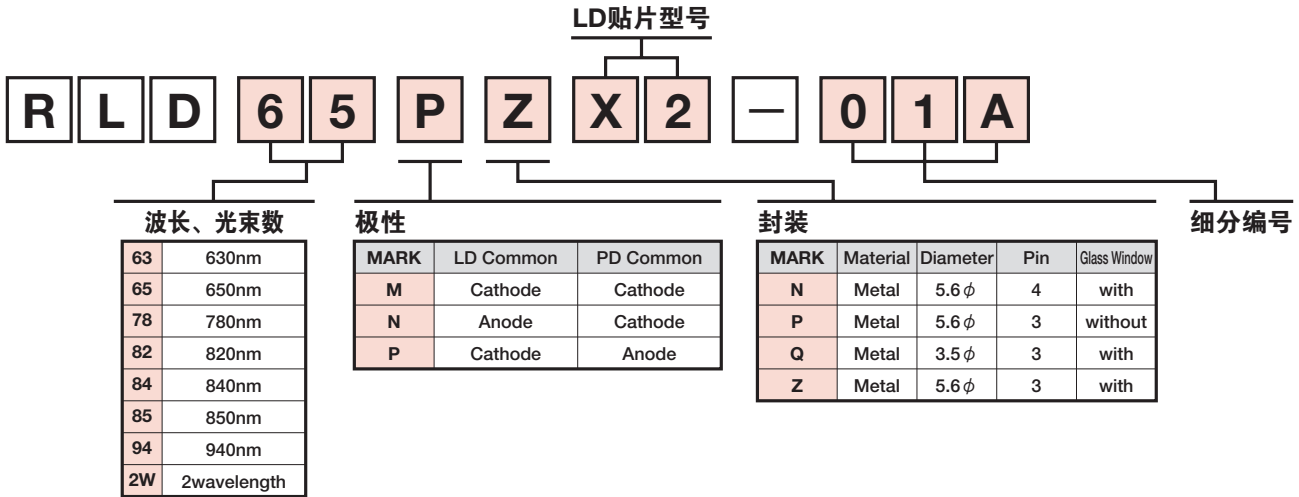

## ● 记号和定义

### ■ 绝对最大额定值

在任何外部条件下, 就是瞬间也不得超过的数值即绝对最大额定值。  
以外壳温度 $T_c = 25^\circ\text{C}$ 时的数值作出规定。

Parameter	Symbol	Definition
Optical Output	$P_o$	Maximum allowable optical output during continuous or pulse operation. No kinks will appear in the output vs. forward current curve up to this output value. (Fig.1)
Reverse Voltage	$V_R$	The maximum allowable voltage when a reverse bias is applied to the device. Lasers and photo diodes are rated separately.
Operating Temperature	$T_{opr}$	Allowed ambient temperature range when the device is in operation. Delined to be the case temperature of the device.
Storage Temperature	$T_{stg}$	Allowed temperature range when the device is being stored.

■ Fig.1 光输出-正向电流特性

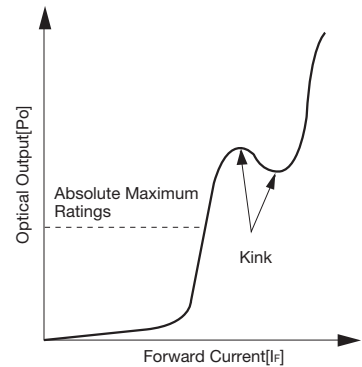

### ■ 电气及光学特性

Item	Symbol	Definition
Threshold Current	$I_{th}$	In Fig.2, A is the spontaneous emission range and B is the stimulated emission range. The threshold current is the current at which laser emission begins.
Operating Current	$I_{op}$	The forward current required to generate the specified optical output.
Operating Voltage	$V_{op}$	The forward voltage required to generate the specified optical output.
Differential Efficiency	$\eta$	The average increase in the output per unit of drive current. In the laser emission range, this is the slope of the linear optical output vs. forward current curve. (Fig.2)
Monitor Current	$I_m$	When the specified optical output is generated, this is the output current of the photodiode when a specified reverse voltage is applied to the monitor photodiode.
Parallel Divergence Angle Perpendicular Divergence Angle	$\theta_{//}$ $\theta_{\perp}$	Light emitted from the laser spreads as shown in Fig.3. The result of measurements of this spread in the parallel (x) and perpendicular (y) directions with respect to the junction surface is shown in Fig.3. The widths of the spread at the points where the strength drops to 1/2 the peak strength (half value full angles) are defined as angles and called $\theta_{//}$ and $\theta_{\perp}$ . (Fig.4)
Parallel Deviation Angle Perpendicular Deviation Angle	$\Delta\phi_{//}$ $\Delta\phi_{\perp}$	These values express the deviation of the optical axis with respect to the reference plane, and are defined for the parallel and perpendicular spread angles (Fig.4) to be $(a - b)/2$ (Fig.5).
Emission Point Accuracy	$\Delta X, \Delta Y, \Delta Z$	This indicates the amount of deviation of the emission point. $\Delta X$ and $\Delta Y$ indicate deviation from the center of the package, and $\Delta Z$ indicates deviation from the reference plane. (Fig.6)
Peak Emission Wavelength	$\lambda$	Peak emission wavelength when generating the specified output. As shown in Fig.7, the emission spectrum has both a single mode and a multimode. In the multimode, the wavelength is delined as the wavelength with the highest intensity.

■ Fig.2 光输出-正向电流特性

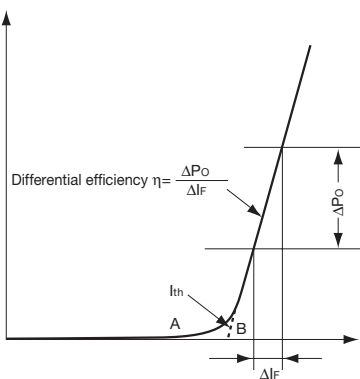

■ Fig.3 辐射特性

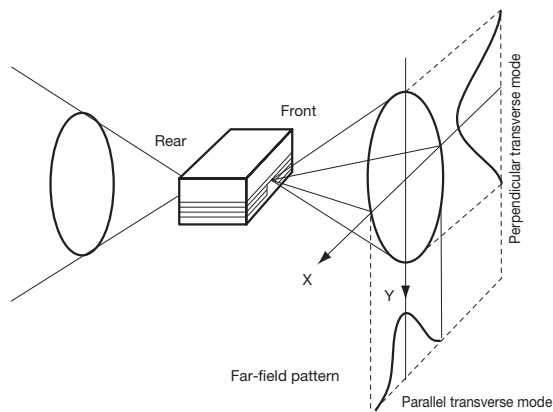

■ Fig.4 辐射特性

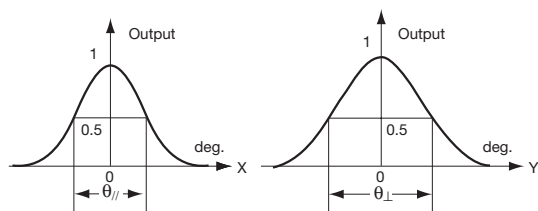

■ Fig.5 光轴倾角

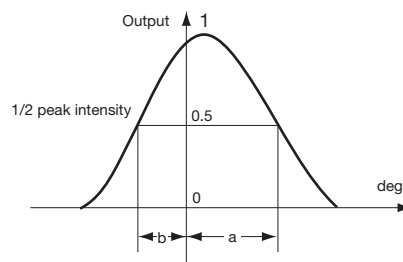

■ Fig.6 发光点位置

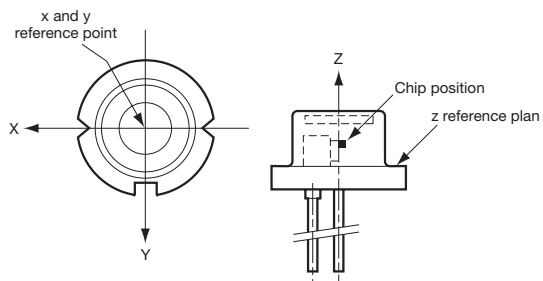

■ Fig.7 振荡光谱特性

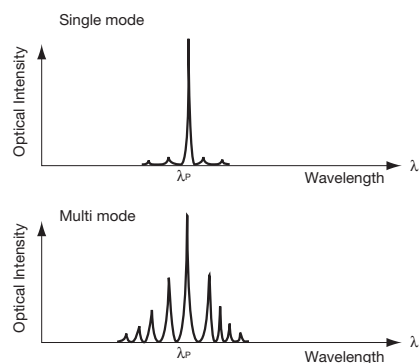

# 封装规格

## ●外形尺寸图 (单位: mm)

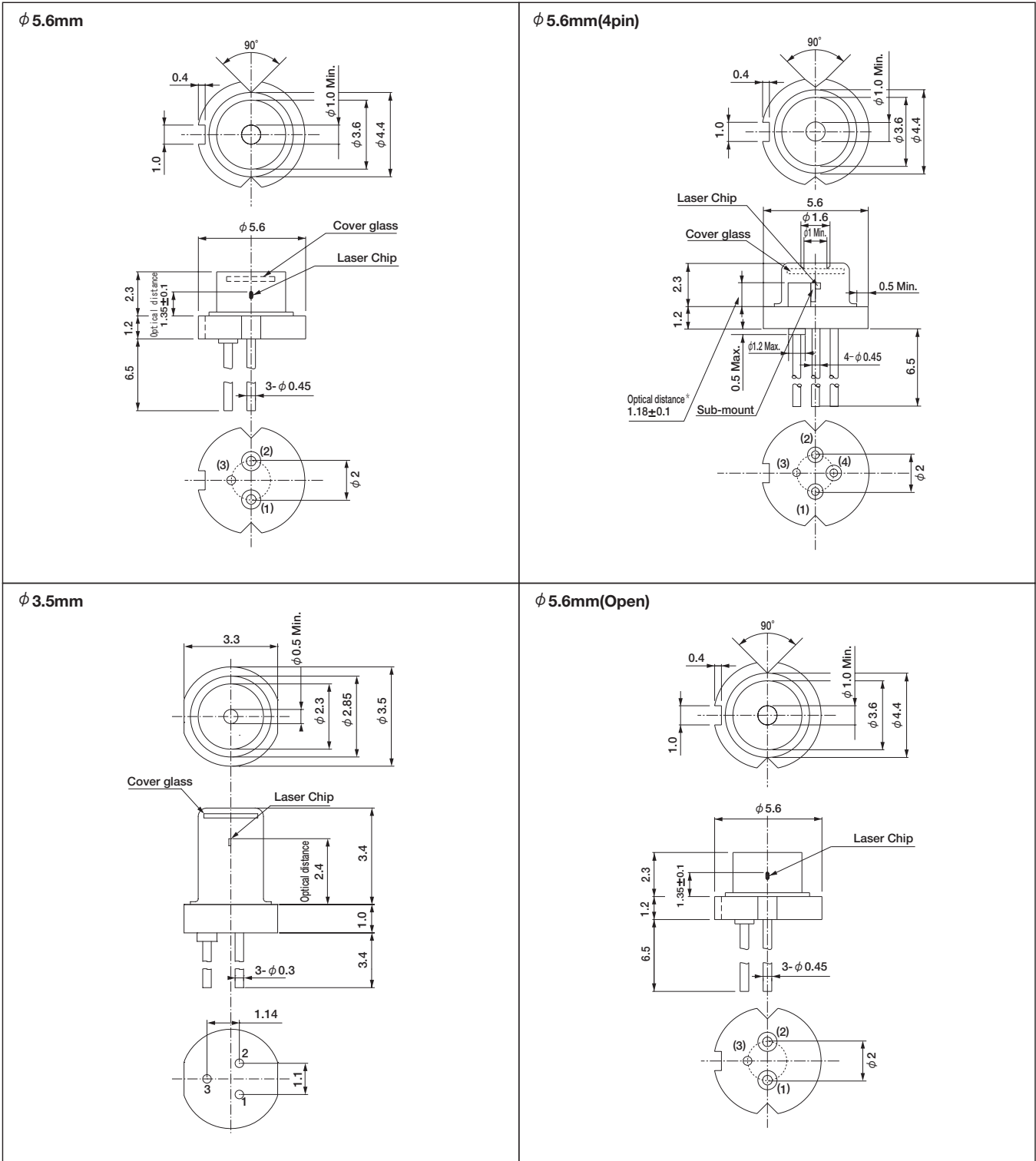

\*: 根据品名有所不同, 使用前请务必确认规格书。